

# OMNIVISION 2023

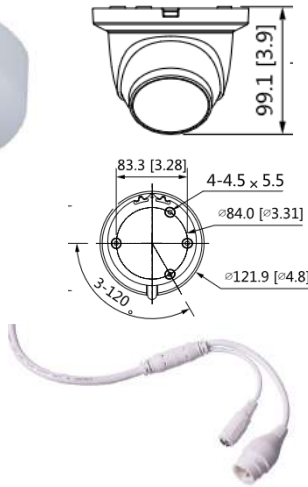



## Dimensions (mm)

**CAMÉRA EYEBALL IP**

CMOS 4MP À 25/30 IPS  
 SMART H.265+ ET H.264+  
 OBJECTIF FIXE 2,8MM  
 LED IR INTÉGRÉE - IR MAX 30M  
 MICRO  
 DÉTECTION INTELLIGENTE  
 DÉTECTION D'ANOMALIE  
 WDR PLAGE DYNAMIQUE ETENDUE  
 DNR REDUCTION DU BRUIT  
 HLC COMPENSATION DE LUMIÈRE VIVE  
 BLC COMPENSATION DE CONTRE JOUR  
 MICRO SD MAX 256GO  
 IP67 - IK10  
 ALIMENTATION 12 V CC/POE

**Code article**
**Prix**

IPCHDW243ITM-AS-S2

130.00€

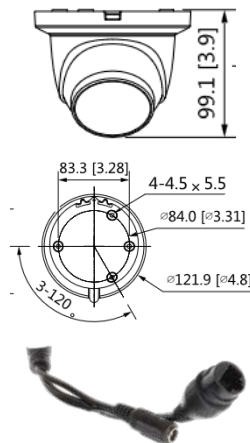

## Dimensions (mm)

**CAMÉRA EYEBALL NOIR IP**

CMOS 4MP À 25/30 IPS  
 SMART H.265+ ET H.264+  
 OBJECTIF FIXE 2,8MM  
 LED IR INTÉGRÉE - IR MAX 30M  
 MICRO  
 DÉTECTION INTELLIGENTE  
 DÉTECTION D'ANOMALIE  
 WDR PLAGE DYNAMIQUE ETENDUE  
 DNR REDUCTION DU BRUIT  
 HLC COMPENSATION DE LUMIÈRE VIVE  
 BLC COMPENSATION DE CONTRE JOUR  
 MICRO SD MAX 256GO  
 IP67 - IK10  
 ALIMENTATION 12 V CC/POE

**Code article**
**Prix**

IPCHDW243ITM-PAS-S2-B

140.00€





## Dimensions (mm)



## CAMÉRA DÔME IR LITE

CMOS 5MP À 20 IPS 5MP  
 SMART H.265+ ET H.264+  
 OBJECTIF FIXE 2,8MM  
 LED IR INTÉGRÉE - IR MAX 30M  
 DÉTECTION INTELLIGENTE  
 DÉTECTION D'ANOMALIE  
 WDR PLAGE DYNAMIQUE ETENDUE  
 DNR REDUCTION DU BRUIT  
 HLC COMPENSATION DE LUMIÈRE VIVE  
 BLC COMPENSATION DE CONTRE JOUR  
 MICRO SD MAX 256GO  
 IP67 - IK10  
 ALIMENTATION 12 V CC/POE

Code article

Prix

IPCHDBW2531EP-SS2

160.00€



## Dimensions (mm)

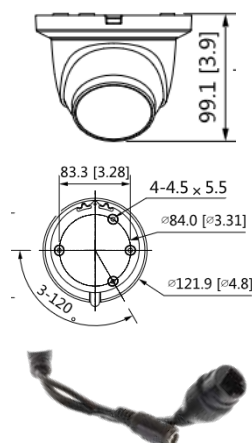

## CAMÉRA EYEBALL NOIR IP

CMOS 5MP À 20 IPS  
 OBJECTIF FIXE 2,8MM  
 LED IR INTÉGRÉE - IR MAX 30M  
 SMD DÉTECTION DE MOUVEMENTS INTELLIGENT  
 DÉTECTION D'ANOMALIE  
 WDR PLAGE DYNAMIQUE ETENDUE  
 DNR REDUCTION DU BRUIT  
 HLC COMPENSATION DE LUMIÈRE VIVE  
 BLC COMPENSATION DE CONTRE JOUR  
 MICRO SD MAX 256GO  
 IP67 - IK10  
 ALIMENTATION 12 V CC/POE

Code article

Prix

IPCHDW2541TMS080BLACK

170.00€



## Dimensions (mm)

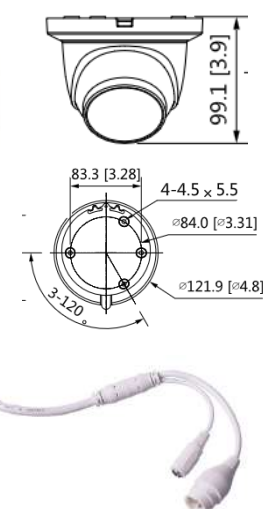

## CAMÉRA EYEBALL IP

CMOS 5MP À 20 IPS  
 SMART H.265+ ET H.264+  
 OBJECTIF FIXE 2,8MM  
 AUTOFOCUS IR MAX 50M  
 MICRO  
 120DB WDR  
 SMD DÉTECTION DE MOUVEMENTS INTELLIGENT  
 DÉTECTION D'ANOMALIE  
 WDR PLAGE DYNAMIQUE ETENDUE  
 DNR REDUCTION DU BRUIT  
 HLC COMPENSATION DE LUMIÈRE VIVE  
 BLC COMPENSATION DE CONTRE JOUR  
 MICRO SD MAX 256GO  
 IP67 - IK10  
 ALIMENTATION 12 V CC/POE

Code article

Prix

IPCHDW3541TMPAS-0280B

176.00€

## Dimensions (mm)

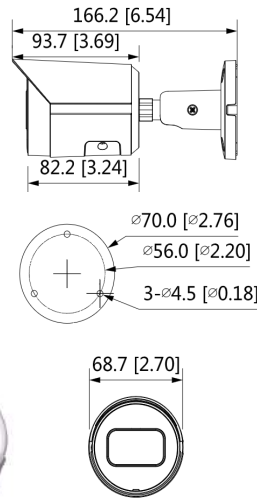
**CAMÉRA BULLET IP**

CMOS 8MP À 15 IPS  
 SMART H.265+ ET H.264+  
 OBJECTIF FIXE 2,8MM  
 AUTOFOCUS IR MAX 30M  
 MICRO  
 120DB WDR  
 DETECTION INTELLIGENTE  
 DÉTECTION D'ANOMALIE  
 WDR PLAGES DYNAMIQUES ÉTENDUES  
 DNR RÉDUCTION DU BRUIT  
 HLC COMPENSATION DE LUMIÈRE VIVE  
 BLC COMPENSATION DE CONTRE JOUR  
 MICRO SD MAX 256GO  
 IP67 - IK10  
 ALIMENTATION 12 V CC/POE

**Code article**
**Prix**

IPCHFW2831S-S-S2

140.00€

## Dimensions (mm)

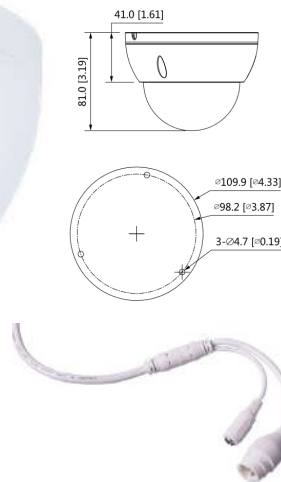
**CAMÉRA DOME IP**

CMOS 8MP À 15 IPS  
 SMART H.265+ ET H.264+  
 OBJECTIF FIXE 2,8MM  
 LED IR INTÉGRÉE - IR MAX 30M  
 MODE DE ROTATION  
 DETECTION INTELLIGENTE  
 DÉTECTION D'ANOMALIE  
 WDR PLAGES DYNAMIQUES ÉTENDUES  
 DNR RÉDUCTION DU BRUIT  
 HLC COMPENSATION DE LUMIÈRE VIVE  
 BLC COMPENSATION DE CONTRE JOUR  
 MICRO SD MAX 256GO  
 IP67 - IK10  
 ALIMENTATION 12 V CC/POE

**Code article**
**Prix**

IPCHDBW2831E-S-S2

200.00€

## Dimensions (mm)

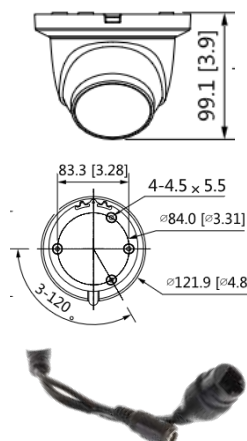
**CAMÉRA EYEBALL NOIR IP**

CMOS 8MP À 20 IPS  
 SMART H.265+ ET H.264+  
 OBJECTIF FIXE 2,8MM  
 LED IR INTÉGRÉE - IR MAX 30M  
 WIZSENSE  
 MODE DE ROTATION  
 SMD DÉTECTION DE MOUVEMENTS INTELLIGENTE  
 DÉTECTION D'ANOMALIE  
 WDR PLAGES DYNAMIQUES ÉTENDUES  
 DNR RÉDUCTION DU BRUIT  
 HLC COMPENSATION DE LUMIÈRE VIVE  
 BLC COMPENSATION DE CONTRE JOUR  
 MICRO SD MAX 256GO  
 IP67 - IK10  
 ALIMENTATION 12 V CC/POE

**Code article**
**Prix**

IIPCHDW3841TMPAS-B

236.00€

## Dimensions (mm)

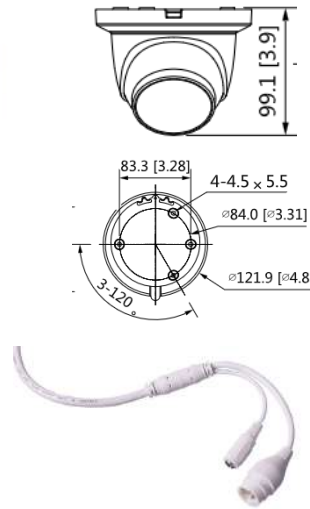
**CAMÉRA EYEBALL IP**

CMOS 8MP À 15 IPS  
 SMART H.265+ ET H.264+  
 OBJECTIF FIXE 2,8MM  
 AUTOFOCUS IR MAX 50M  
 MICRO  
 120DB WDR  
 SMD DETECTION DE MOUVEMENTS INTELLIGENT  
 DÉTECTION D'ANOMALIE  
 WDR PLAGE DYNAMIQUE ETENDUE  
 DNR REDUCTION DU BRUIT  
 HLC COMPENSATION DE LUMIÈRE VIVE  
 BLC COMPENSATION DE CONTRE JOUR  
 MICRO SD MAX 256GO  
 IP67 - IK10  
 ALIMENTATION 12 V CC/POE

Code article

Prix

HDW3841EM-S-S2

256.00€

## Dimensions (mm)

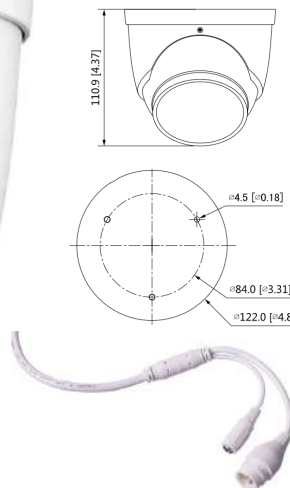
**CAMÉRA EYEBALL COULEUR IP**

CMOS 8MP À 25/30 IPS  
 CAMÉRA FULL-COLOR  
 OBJECTIF FIXE 2,8MM  
 LED IR INTÉGRÉE - IR MAX 30M  
 MICRO INTÉGRÉ ET HAUTS PARLEURS  
 WIZZ SENSE PROTECTION PERIMÉTRIQUE  
 SMD 3.0 DETECTION DE MOUVEMENTS INTELLIGENTE  
 DÉTECTION D'ANOMALIE  
 WDR PLAGE DYNAMIQUE ETENDUE  
 DNR REDUCTION DU BRUIT  
 HLC COMPENSATION DE LUMIÈRE VIVE  
 BLC COMPENSATION DE CONTRE JOUR  
 MICRO SD MAX 256GO  
 ALARME  
 IP67 - IK10  
 ALIMENTATION 12 V CC/POE

Code article

Prix

IPCHDW3849H-ASPV-S3

270.00€

Nouvelle génération de caméras Full Color  
 avec technologie à double objectif pour la  
 fusion d'images IR et des images couleur



**Dimensions (mm)**

**CAMÉRA PTZ DOME IP**

CMOS 4MP À 25/30 IPS  
 OBJECTIF MOTORISÉ 2.7-11MM  
 AUTOFOCUS  
 WDR PLAGE DYNAMIQUE ETENDUE  
 IVS  
 IP66 - IK10  
 ALIMENTATION 12 V CC/POE

**Code article**
**Prix**

SD22404TGN-S2

250.00€

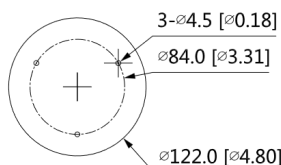
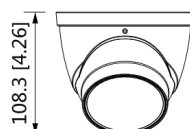

**Dimensions (mm)**

**CAMÉRA EYBALL IP**

CMOS 8MP À 20 IPS  
 OBJECTIF MOTORISÉ 2,7-13,5MM  
 LED IR INTÉGRÉE - IR MAX 50M  
 MICRO INTÉGRÉ  
 MODE ROTATION  
 SMD + DETECTION DE MOUVEMENTS INTELLIGENTE  
 DÉTECTION D'ANOMALIE  
 WDR PLAGE DYNAMIQUE ETENDUE  
 DNR REDUCTION DU BRUIT  
 HLC COMPENSATION DE LUMIÈRE VIVE  
 BLC COMPENSATION DE CONTRE JOUR  
 MICRO SD MAX 256GO  
 IP67 - IK10  
 ALIMENTATION 12 V CC/POE

**Code article**
**Prix**

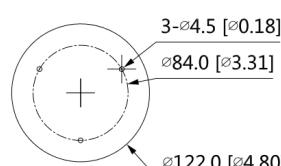
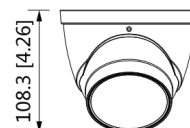
IPCHDW3841T-ZAS

320.00€

**Dimensions (mm)**

**CAMÉRA EYEBALL NOIR COULEUR IP**

CMOS 8MP À 20 IPS  
 CAMERA COULEUR  
 OBJECTIF MOTORISÉ 2,7-13,5MM  
 LED IR INTÉGRÉE - IR MAX 50M  
 MICRO INTÉGRÉ  
 MODE ROTATION  
 SMD + DETECTION DE MOUVEMENTS INTELLIGENTE  
 DÉTECTION D'ANOMALIE  
 WDR PLAGE DYNAMIQUE ETENDUE  
 DNR REDUCTION DU BRUIT  
 HLC COMPENSATION DE LUMIÈRE VIVE  
 BLC COMPENSATION DE CONTRE JOUR  
 MICRO SD MAX 256GO  
 IP67 - IK10  
 ALIMENTATION 12 V CC/POE

**Code article**
**Prix**

IPCHDW3841T-ZAS BLACK

320.00€



**ahua**  
TECHNOLOGY

# 3-in-1 Camera TI0C 2.0

Your Effective Deterrent Against Intruders

-  Smart Dual Illuminators
-  Active Deterrence
-  **Wiz Sense**  
Artificial Intelligence

# Full-Color Camera



**KIT COMPLET 4 CAMERAS 4MP + ENREGISTREUR + DISQUE DUR 2GB**

KIT COMPOSE DE :

 4x CAMERAS : IPCHDW2431TM-AS-S2  
 1x ENREGISTREUR : NVR4104HS-P-4KS2/L  
 1x DISQUE DUR : WD20PURZ

**Code article**
**Prix**

KIT 1

874.00€

**KIT COMPLET 4 CAMERAS 5MP + ENREGISTREUR + DISQUE DUR 2GB**

KIT COMPOSE DE :

 4x CAMERAS : IPCHDBW2531EP-SS2  
 1x ENREGISTREUR : NVR4104HS-P-4KS2/L  
 1x DISQUE DUR : WD20PURZ

**Code article**
**Prix**

KIT 2

994.00€

**KIT COMPLET 8 CAMERAS 8MP + ENREGISTREUR + DISQUE DUR 4GB**

KIT COMPOSE DE :

 8x CAMERAS : IPCHFW2831S-S-S2  
 1x ENREGISTREUR : NVR4108HS-P-4KS2  
 1x DISQUE DUR : WD40PURZ

**Code article**
**Prix**

KIT 3

1560.00€



**KIT COMPLET 4 CAMERAS 8MP + ENREGISTREUR + DISQUE DUR 4GB****@hua**

KIT COMPOSE DE :

4x CAMERAS : IIPCHDW384ITMPAS-B  
 1x ENREGISTREUR : NVR4104HS-P-4KS2/L  
 1x DISQUE DUR : WD40PURZ

Code article

Prix

KIT 4

1348.00€

**KIT COMPLET 4 CAMERAS 8MP + ENREGISTREUR + DISQUE DUR 4GB****@hua**

KIT COMPOSE DE :

4x CAMERAS : IPCHDBW2831E-S-S2  
 1x ENREGISTREUR : NVR4104HS-P-4KS2/L  
 1x DISQUE DUR : WD40PURZ

Code article

Prix

KIT 5

1204.00€

**KIT COMPLET 8 CAMERAS 8MP + ENREGISTREUR + DISQUE DUR 4GB****@hua**

KIT COMPOSE DE :

8x CAMERAS : IIPCHDW384ITMPAS-B  
 1x ENREGISTREUR : NVR4108HS-P-4KS2  
 1x DISQUE DUR : WD40PURZ

Code article

Prix

KIT 6

2328.00€



SUPPORT EN ALUMINIUM BLANC  
IP66  
110 MM X 32 MM

Code article	Prix
PFA130-E	24.00€



SUPPORT EN ALUMINIUM BLANC  
IP66  
160 MM X 122 MM X 76 MM

Code article	Prix
PFB203W	20.00€



SUPPORT EN ALUMINIUM NOIR  
IP66  
110 MM X 32 MM

Code article	Prix
PFA130-EB	28.00€



SUPPORT EN ALUMINIUM NOIR  
IP66  
160 MM X 122 MM X 76 MM

Code article	Prix
PFB203WB	20.00€



**SWITCH**  
POE  
MANAGEABLE  
240W

Code article	Prix
8ports : PFS3010-8ET-96	90.00€
16ports : PFS4218-16GT-240	330.00€
24ports : PFS4226-24ET-360	460.00€

## APPLICATION

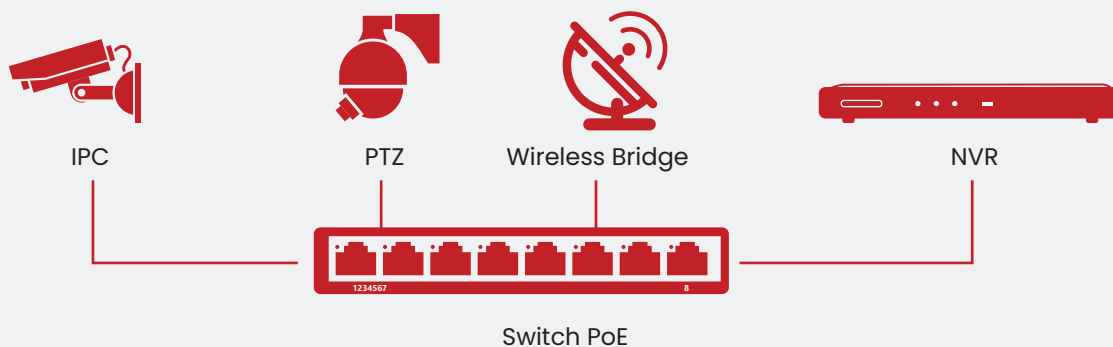

Haute protection



PoE intelligent



Large température de travail



PoE longue distance



**NVR ENREGISTREUR 4K**

4 CANAUX POE  
80MBPS  
H.265  
HDMI, VGA, USB, LAN  
MAX 8MP  
SANS DISQUE DUR

**Code article**
**Prix**
**NVR4104HS-P-4KS2/L**
**224.00€**

**NVR ENREGISTREUR 4K**

8 CANAUX POE  
80MBPS  
H.265  
HDMI, VGA, USB, LAN  
MAX 8MP  
SANS DISQUE DUR

**Code article**
**Prix**
**NVR4108HS-P-4KS2**
**260.00€**

**NVR ENREGISTREUR 4K**

8 CANAUX POE  
256MBPS  
H.265  
HDMI, VGA, USB, RS232, LAN  
MAX 8MP  
ENTRÉES ET SORTIES ALARME  
2 EMPLACEMENTS DISQUE DUR  
SANS DISQUE DUR

**Code article**
**Prix**
**NVR4208-8P-4KS2/L**
**380.00€**

**NVR ENREGISTREUR 4K**

16 CANAUX POE  
320MBPS  
H.265  
HDMI, VGA, USB, RS232, LAN  
MAX 8MP  
ENTRÉES ET SORTIES ALARME  
2 EMPLACEMENTS DISQUES DURS  
SANS DISQUE DUR

Code article

Prix

NVR4216-16P-KS2/L

460.00€

**NV RENREGISTREUR 4K**

16 CANAUX POE  
8 PORTS EPOE  
320MBPS  
H.265  
MAX 12MP  
HDMI, VGA, USB, RS232, LAN  
ENTRÉES ET SORTIES ALARME  
MAX 2 DISQUES DURS  
SANS DISQUE DUR

Code article

Prix

NVR5216-16P-4KS2E

620.00€

**NVR ENREGISTREUR 4K**

320MBPS  
32 CANAUX  
H.265  
HDMI, VGA, USB, RS232, SATA, DUAL LAN  
MAX. 12MP  
ENTRÉES ET SORTIES ALARME  
MAX 4 DISQUES DURS  
SANS DISQUE DUR

Code article

Prix

NVR5432-4KS2

620.00€



DISQUE DUR  
2 TB  
PURPLE

Code article	Prix
WD20PURZ	130.00€



DISQUE DUR  
4 TB  
PURPLE

Code article	Prix
WD40PURZ	180.00€



DISQUE DUR  
6 TB  
PURPLE

Code article	Prix
WD60PURZ	330.00€

**NVR & DVR Surveillance Systems**  
**Up to 64 Cameras Per HDD**



**TESTEUR DE MONTAGE INTEGRE \*HS**

ÉCRAN TFT 4,0"  
RÉSOLUTION 800 × 480,  
AFFICHAGE DE DÉCODAGE H.264 / H.265 POUR IPC  
CONTRÔLE DE L’AFFICHAGE VIDÉO  
HDCVI / AHD / TVI / CVBS  
ALIMENTATION CC 12V / 2A POUR LA CAMÉRA  
FONCTIONS DU MULTIMÈTRE NUMÉRIQUE

Code article	Prix
--------------	------

PFM900-E	sur demande
----------	-------------



**KIT OUTILLAGE CÂBLAGE ET TEST \*HS**

KIT D’OUTILLAGE CÂBLAGE ET TEST RJ,  
REGROUPANT UN TESTEUR DIAGLC90  
ET L’OUTILLAGE DE BASE  
DÉNUDEUR GGM 907X501  
PINCE COUPANTE GGM 907CUT15S  
TESTEUR DE CONTINUITÉ GGM DIAGLC90  
ETUI SOUPLE

Code article	Prix
--------------	------

KITLC90	sur demande
---------	-------------



**PINCE A SERTIR AVEC GAINÉ**

OUTIL PROFESSIONNEL  
COUPER ET DÉNUDER  
CÂBLES DE TÉLÉPHONE PLATS NON BLINDÉS.  
FICHE WESTERN À 6 ET 8 PÔLES  
TYPE RJ 11/12  
TYPE RJ 45  
SERTISSAGE PRÉCIS

Code article	Prix
--------------	------

97 51 10 SB	46.10€
-------------	--------



**TRACEUR DE CÂBLE SONORE**

SIGNAL JUSQU’A 16 KM SUR LA PLUPART DES CÂBLES  
GENERATEUR DE TONALITE ANALOGIQUE  
PINCE A LIT DE CLOUS  
SONDE NON FILTERE  
5 TONALITES DISTINCTES  
TEST DE CONTINUITÉ ET DE POLARITÉ  
DESIGN ERGONOMIQUE ET ELEGANT  
PRISE CASQUE 3.5 JACK

Code article	Prix
--------------	------

PRO3000F50KIT	324.46€
---------------	---------

**CABLE UTP**  
 CAT 6

Code article	Prix
06.00485 - 5M	4.75€
06.00486 - 10M	7.82€
06.00487 - 15M	9.82€
06.00488 - 20M	12.89€
06.00489 - 30M	16.85€

**CABLE UTP**  
 CAT 6

Code article	Prix
06.00510 - par mètre	0.86€
06.00511 - par 305 M	266.16€

**FICHE RJ45 RENFORCE**  
 CAT 6

Code article	Prix
06.00633 - par 6 pièces	13.64€

**FICHE RJ45**  
 CAT 6 SIMPLE

Code article	Prix
06.00634 - par 100 pièces	40.00€

**FICHE MODULE UNIVERSEL RJ45**  
 CAT 6 - 8 POSITIONS

Code article	Prix
06.00374	13.29€





A series of horizontal dotted lines for writing notes.



## JETTE

Rue Leopold 1, 402  
1090 Jette  
Tél. : 02 426 74 24  
jette@omnitec.be

## FOREST

Chaussée de Neerstalle, 83  
1190 Forest  
Tél. : 02 219 53 34  
forest@omnitec.be

## SAINT-GILLES

Chaussée de Forest, 83  
1060 Saint-Gilles  
Tél. : 02 538 62 14  
saint-gilles@omnitec.be

## SCHAERBEEK

Chaussée de Louvain, 675  
1030 Schaerbeek  
Tél. : 02 726 15 11  
schaerbeek@omnitec.be

## IXELLES

Chaussée de Boondael, 315-317  
1050 Ixelles  
Tél : 02 344 24 92  
ixelles@omnitec.be

## WATERLOO

Avenue des paquerettes, 2  
1410 Waterloo  
Tél : 02 476 08 77  
waterloo@omnitec.be